

D
C
B
A

D
C
B
A

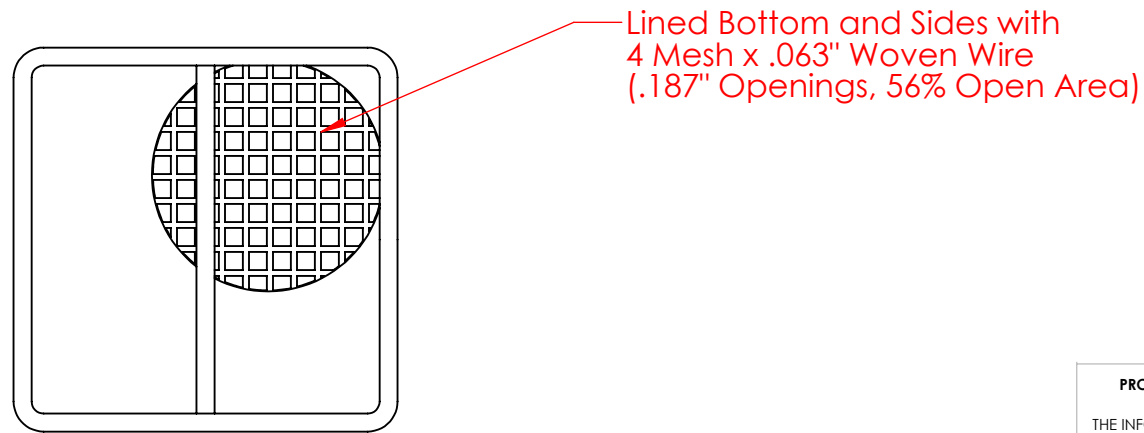
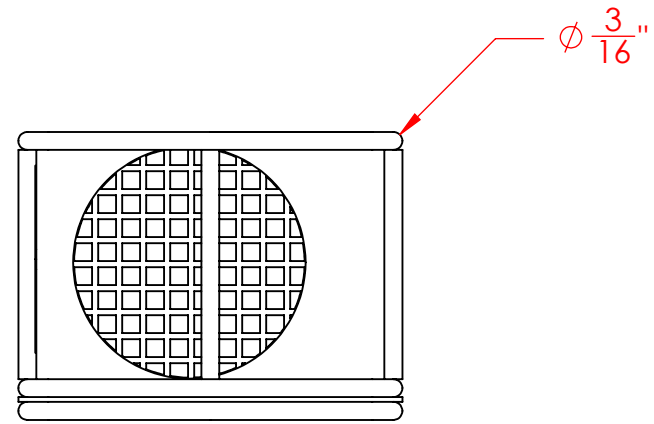
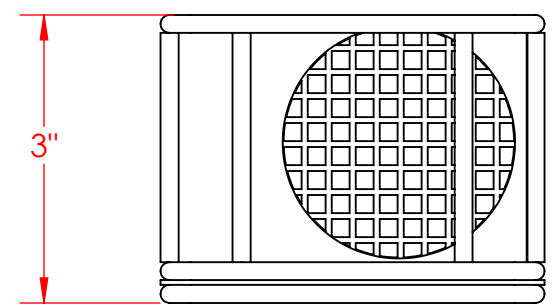
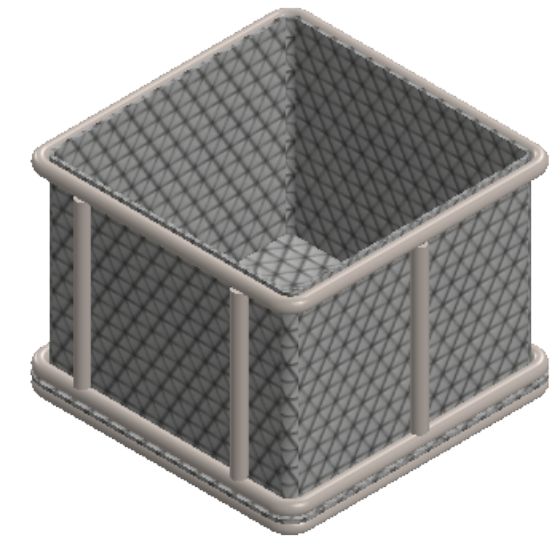
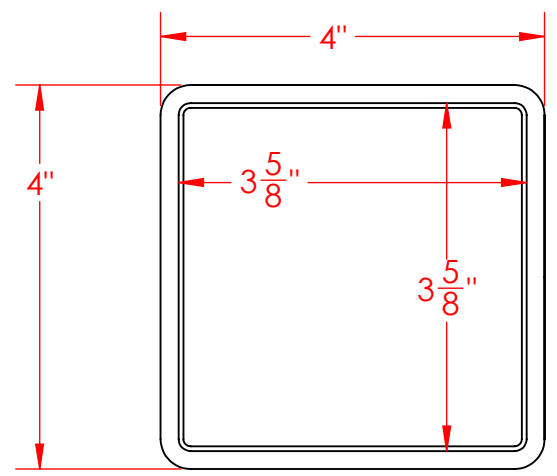

UNLESS OTHERWISE SPECIFIED:
DIMENSIONS ARE IN INCHES
TOLERANCES:
FRACTIONAL $\pm 1/16$ "
ANGULAR: ± 5 DEG.
TWO PLACE DECIMAL ± 0.03
THREE PLACE DECIMAL ± 0.015

EST WGT
0.9 lbs.
MATERIAL
304 Stainless Steel
FINISH
Natural

DO NOT SCALE DRAWING

Rectangular Wire Mesh Basket:
4Lx4Wx3H, 304 SS, 3/16 Rod Frame,
No Handles, Mesh: 4 x .063

SIZE **B** DWG. NO.
TMT-040040030-N04S

SCALE: 1:2

SHEET 1 OF 1

PROPRIETARY AND CONFIDENTIAL
THE INFORMATION CONTAINED IN THIS
DRAWING IS THE SOLE PROPERTY OF
THREE M TOOL. ANY REPRODUCTION IN
PART OR AS A WHOLE WITHOUT THE
WRITTEN PERMISSION OF THREE M TOOL
IS PROHIBITED.